

# WELCOME

Expertly crafted precision joinery  
and quality timber products for your home.



# CONTENTS

1-2	WELCOME & CONTENTS
3-4	OUR STORY
5-6	PART Q
7-8	WALLBRIDGE COLLECTION
9-12	CASEMENT WINDOWS
13-14	WINDOW HANDLES
15-22	DOORS
23-24	BLU HARDWARE BY COSTAL
25-30	SLIDING SASH
31-32	BI-FOLD DOORS
32-33	SCREEN & SHADE SYSTEMS
34-39	BESPOKE & HERITAGE
39-40	STAIRCASES
41-42	STAIRCASES
43-44	TIMBER
45-46	FINISHES & GLASS



# OUR STORY

Established in 1978, GK Joinery Ltd started in a small workshop in Locking Hill, Stroud with a simple mission - to manufacture purpose-made, premium timber products.

The business was quick to earn the trust of local homeowners and tradesmen with our quality craftsmanship and outstanding service. Over 40 years on, we continue to pride ourselves on maintaining this reputation. In fact, the majority of our work still comes from customer referrals. This demonstrates the trust our customers place in us to deliver the highest quality products and customer service - which they say set us apart.

This local family-owned business has gone from strength to strength, investing in our workshop, employees and the latest technology without compromising on traditional aesthetics or craftsmanship. This allows us to continue our mission of making long-lasting, quality timber products that meet today's high standards.

"Our trust in GK was fully endorsed - outstanding service from first meeting to after fitting check."

Gus Grimshaw, Oak Conservatory





# Part Q

## Security Rated Doors & Windows

On the 1st October 2015 Part Q was introduced to England building regulations. This means that anyone building a new home needs to ensure that all easily accessible doors and windows must comply with certain security performance requirements as specified in PAS 24:2012.

Through the Joinery Network, we're proudly licenced and able to supply quality, Part Q compliant windows and external doors which have been tested at an approved test centre and will satisfy building control security guidelines.

If you have a new build project or are looking to enhance your home security, then please contact us for your free quotation.



The Joinery Network cascade test certificate to  
**G K Joinery Limited**

This certificate conforms to the following test evidence: -



PAS24  
2016

Enhanced security performance requirements for doorsets and windows in the UK



BS6375-1  
2009

Performance of windows and doors Part 1: Classification for weathertightness



Document  
Q

Security – Dwellings, Windows and Doors



Document  
LB1

Compliance to Conversion of fuel and power in existing dwellings. Thermal U-value 1.4W/m<sup>2</sup>K



Document  
M

Access to and from buildings (Open in doors only currently)



**TESTED**







# GK WALLBRIDGE COLLECTION

The wallbridge collection is the culmination of years of development to produce the highest quality timber windows and doors.

DESIGNED TO SUIT ALL BUILDINGS FROM NEW BUILD TO COTTAGES

**A RATED** - EXCEPTIONAL THERMAL PERFORMANCE

**CUSTOMISABLE** - CHOICE OF MOULDS AND PANEL DETAILS TO SUIT YOU

**PERFORMANCE COATING** - MICRO-POROUS COATING FACTORY APPLIED PROVIDING MAXIMUM PROTECTION

**HIGH SECURITY** - DOORS AND CASEMENT WINDOWS FITTED WITH MULTI POINT LOCKS AND STANDARD

**GREEN CHOICE** - TIMBER IS ALWAYS THE MOST SUSTAINABLE CHOICE, ESPECIALLY WHEN COMPARED TO PVC OR ALUMINIUM

**TIMBER OPTIONS** - FROM LONG LASTING ENGINEERED TIMBER TO ACCOYA WHICH COMES WITH A 50 YEAR GURANTEE AGAINST ROT

WALLBRIDGE COLLECTION DOORS AND WINDOWS ARE INTERNALLY BEADED FOR IMPROVED SECURITY AND WEATHER PERFORMACE

A SLEEK CHAMFER DESIGN EXTERNALLY WITH A CHOICE OF MOULDS INTERNALLY

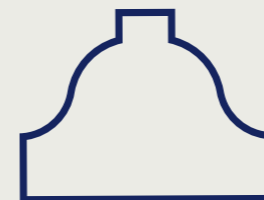

Lamb's Tongue Bars

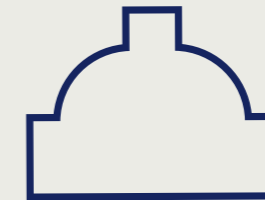

Ovolo Bars

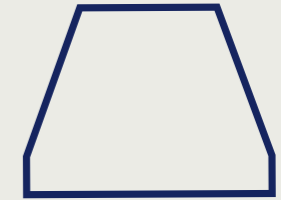

Chamfer Bars

Proudly manufactured in Gloucestershire, we offer the following guarantees on all Wallbridge Collection Products\*

Sealed Unit



10 YEARS GUARANTEE

Hardware



10 YEARS GUARANTEE

Workmanship



10 YEARS GUARANTEE

Paint



10 YEARS GUARANTEE

Stain



UP TO 6 YEARS GUARANTEE

\*Subject to terms and conditions



# WALLBRIDGE COLLECTION CASEMENT WINDOWS



Wallbridge Collection doors and windows are internally beaded for improved security and weather performance. A sleek chamfer profile externally with a choice of 3 moulds internally

Ovolo  
Moulding



Square  
Frame  
Chamfer  
Bead



Lambs  
Tongue  
Moulding

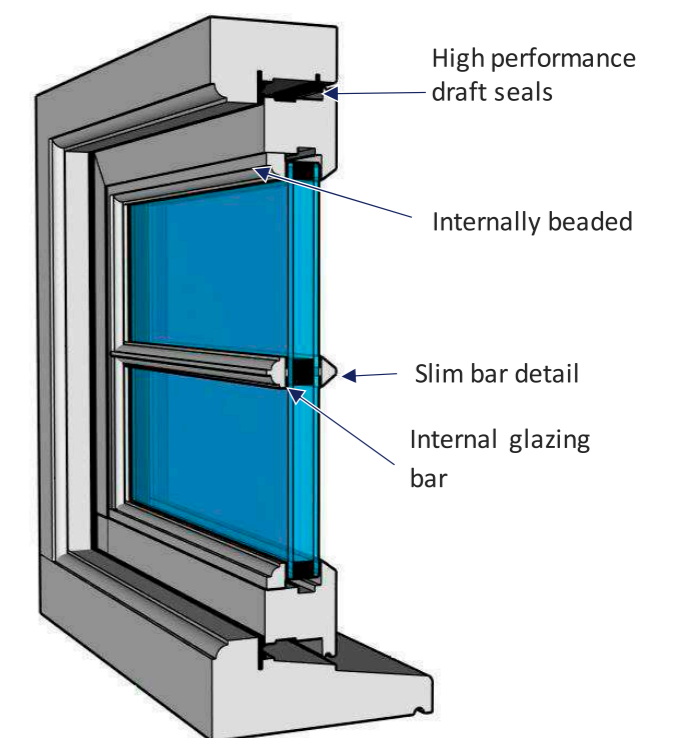
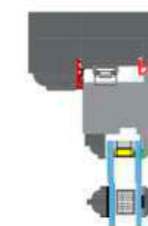





All our windows are made to the highest standard using only the finest quality products available.



Over the years we have invested in quality machinery and tooling, to ensure our windows benefit from modern day security and insulating properties, without compromising on your specific design requirements.





# Window Hardware



## BLU™ WINDOW HANDLES

by COASTAL

- Manufactured from 316 Marine Grade Stainless Steel.
- Ideal for use where corrosion levels are high such as coastal environments and with acidic timber.
- Matching Door and Window hardware range
- Available in Classic and Contemporary styles



For more information about the products Scan QR CODE.

### REG020 - Regent

Finishes:

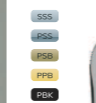

### TBH020 - Opera

Finishes:

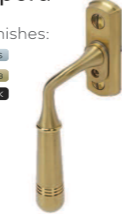

### SST81 - Offset

Finish:



### SST87 - Cranked

Finishes:



### SST94 - Inline

Finishes:



### SST100 - Inline Angled

Finishes:



Using traditional materials and techniques Cardea furniture is built to stand the test of time. Solid sand cast pieces created from molten brass, bronze or iron just as the Romans did over two millennia ago.



## CARDEA RANGE



DARK BRONZE    POLISHED NICKEL    SATIN NICKEL    UNLAQUERED BRASS    WHITE BRONZE    SHERADISED BLACK



# WALLBRIDGE COLLECTION DOORS

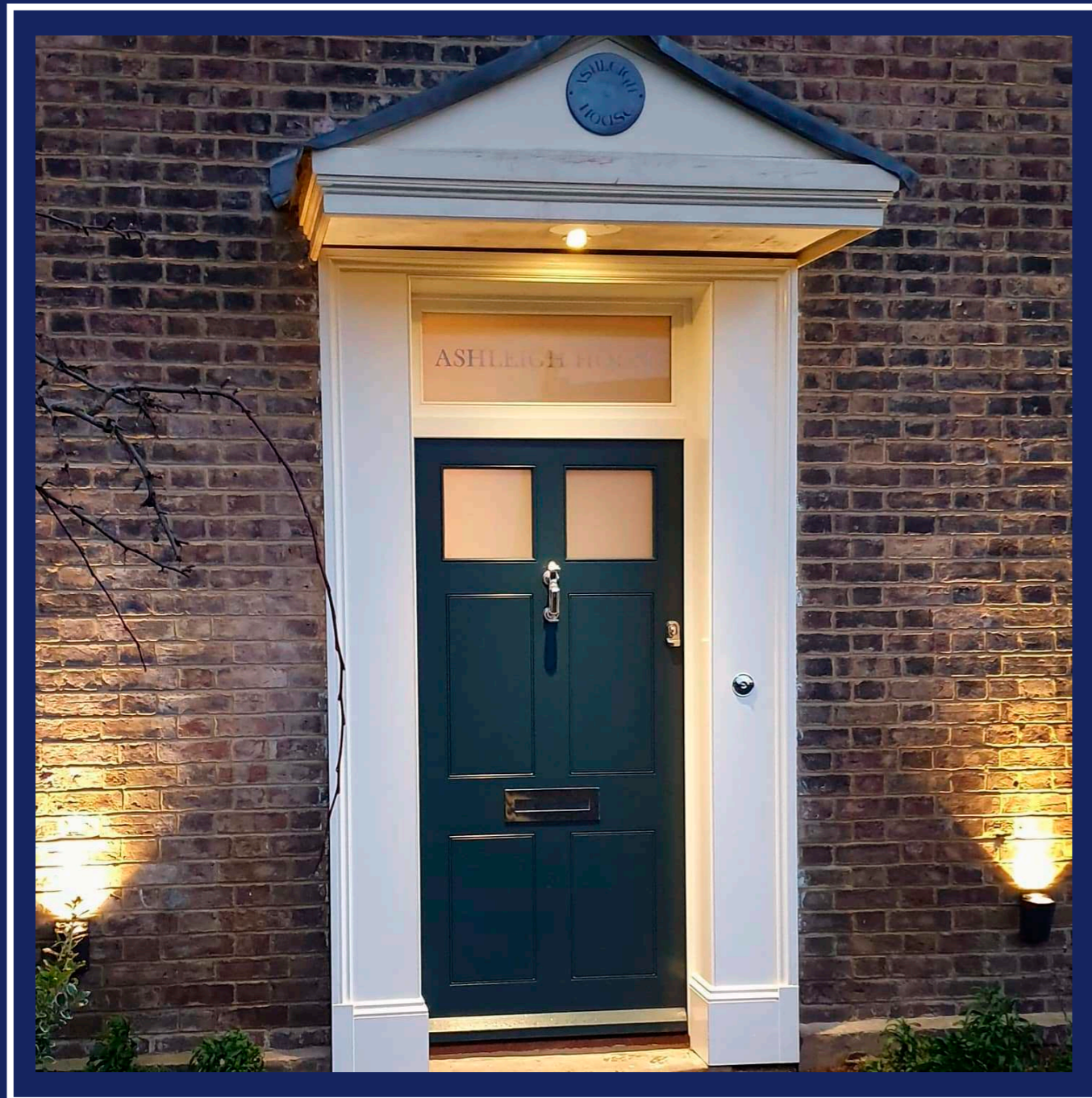

We manufacture all our doors to fit the tastes of you and your property whether that be traditional or contemporary styles.

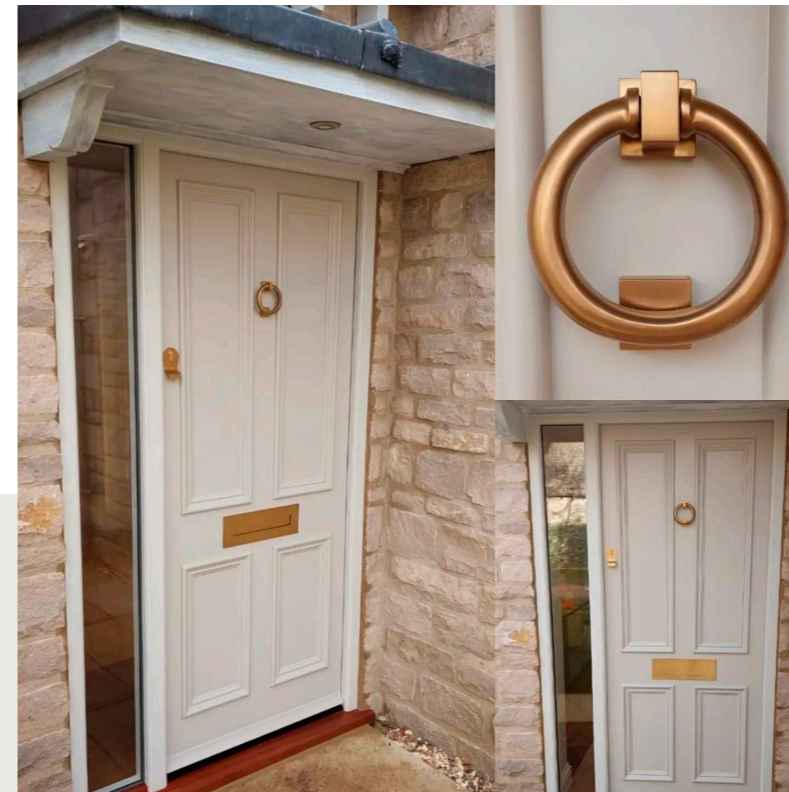

A front door is something you will use every day of your life. It is an introduction to your home, a statement of character, and offers protection and piece of mind.







Modern double glazing and insulated panels enhance the thermal performance  
Multi point locking systems offer the very best protection to your property.





# Entrance Doors

We manufacture all our doors to suit your tastes and that of your property -whether that be traditional or contemporary styles.

Choose your style

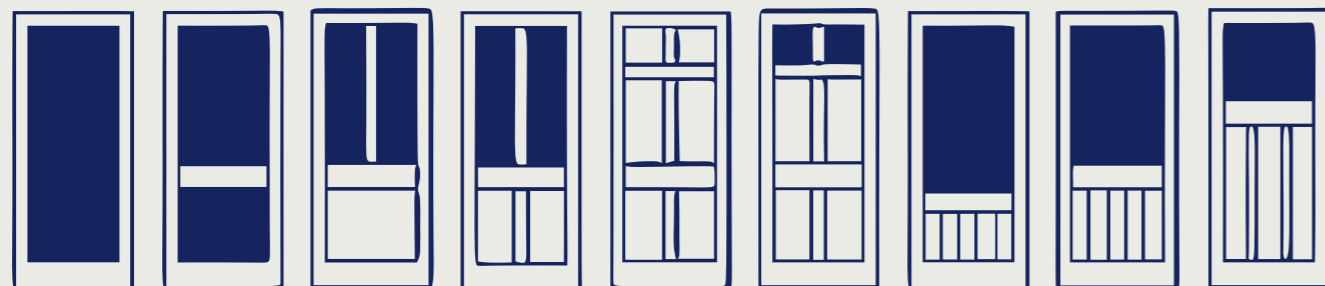
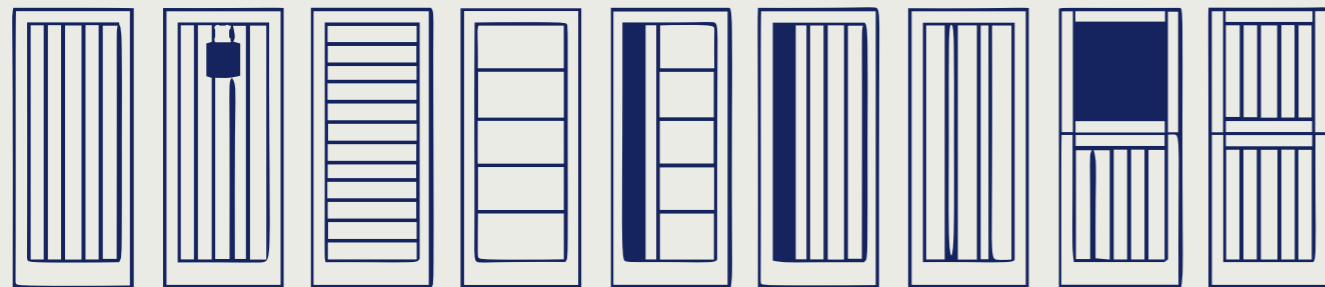
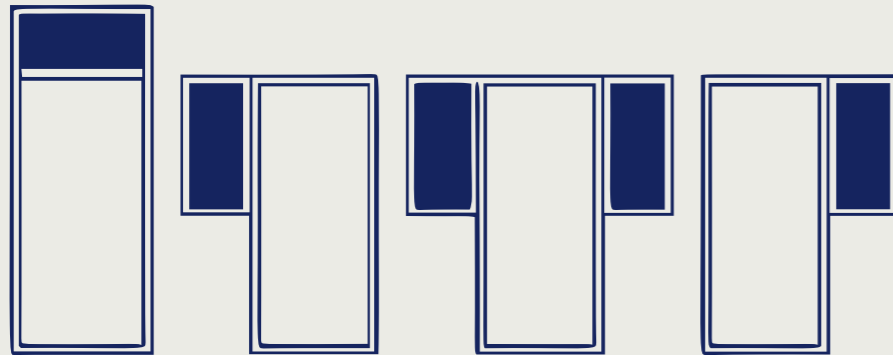

A front door is something you will use every day of your life. It is an introduction to your home, a statement of character and offers protection and security.





# Door Hardware

## CARDEA RANGE

Using traditional materials and techniques Cardea furniture is built to stand the test of time. Solid sand cast pieces created from molten brass, bronze or iron just as the Romans did over two millennia ago.

Tested with Accoya –5 year finish guarantee –5 year parts guarantee –6 Finishes

Bulb end  
Narrow plate



Tapered narrow plate



Bulb end  
Wide plate



Tapered wide plate



UNLAQURED  
BRASS

WHITE  
BRONZE

SHERADIZED  
BLACK

DARK  
BRONZE

SATIN  
NICKEL

POLISHED  
NICKEL



## LOCK OPTIONS

Multi-point locking systems from Winkhaus and Maco for single doors, stable doors, heritage doors and contemporary style doors. Available as lever operated multipoint lock or slam-shut auto multipoint lock.

For more information and keep options **SCAN QR CODE**



### ML196 - Interlocking Stable Door Lock

- Purpose made MACO multipoint door lock for stable door
- Chamfered locking hooks provide excellent weathersealing and make door easy to close and lock
- Integrated shootbolt interlocks top and bottom sashes together to form one door for extra security
- Sashes can be opened together as one unit, or top sash can be opened while bottom remains locked
- Silent latch function.



Hook bolt

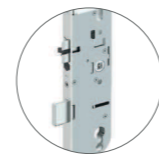

35/45/55mm  
Backset Option



Interlocking



### ML60S/ML66S - Single Door Twin Tapered Deadbolt Lock

- Winkhaus multipoint door lock for single doors.
- Twin tapered deadbolts provide operating force making door to lock whilst providing excellent weathersealing.
- High performance, strengthened centre gearbox.

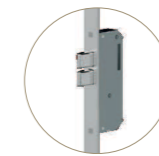

Twin Tapered  
Deadbolts

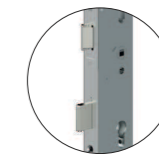

35/45/55mm  
Backset Option



### AV3 Winkhaus Heritage Plus Auto Hook Bolt Door Lock

- Non-Lever Slam Shut Multipoint Lock for Heritage Doors
- Automatic Locking
- Dual Hook bolts
- Magnet only activates the hook bolt once door is closed
- Daytime Latch with the MK48 Keep



Dual Hook bolts



Magnet



MK48 Keep



### Single Handle French Door Lock

- High security locking for double doors without the need for a dummy mullion, dramatically reducing sightlines
- Lever handle on master door only
- U-rail keep on slave door with flick switch for operating shootbolts into head and cill
- Bolts on master door lock directly into slave door

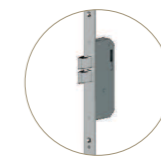

Twin Tapered  
Deadbolts

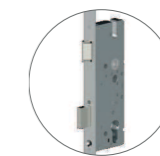

35/45/55mm  
Backset Option



Slave Lock  
Release

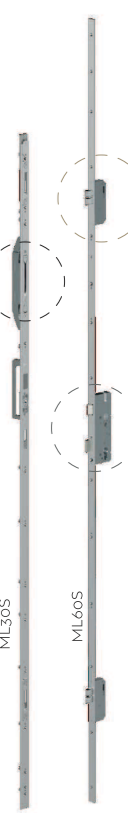





## BLU™ HARDWARE

by COASTAL

BLU™ is a range of 316 Marine Grade Stainless Steel external door and window hardware solutions by Coastal, designed to enhance the aesthetics and performance of doors and windows.

Even in extreme city or coastal environments BLU's 316 Marine Grade durability delivers outstanding protection against corrosion.

### Benefits and Features of BLU Hardware

- Made from 316 Marine Grade Stainless Steel
- Matching Door and Window hardware range
- Available in Classic and Contemporary Styles
- Lifetime Guarantee



Heritage Classic Suited Range  
in PVD Stainless Satin Brass

DKB200 - Classic Ring Door Knocker

Finishes:  
SSS  
PSS  
PSB  
PPB  
PBK



CP30 - Classic Cylinder Pull

Finishes:  
SSS  
PSS  
PSB  
PPB  
PBK



KM388 - Classic Centre Door Knob

Finishes:  
SSS  
PSS  
PSB  
PPB  
PBK



LP400 - Sleeved Letter Plate

Finishes:  
SSS  
PSS  
PSB  
PPB  
PBK

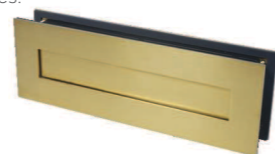

DKB195 - Doctor's Front Door Knocker

Finishes:  
SSS  
PSS  
PSB  
PPB  
PBK



REG090 - Regent Lever Door Handle

Finishes:  
SSS  
PSS  
PSB  
PPB  
PBK



TBH095 - Opera Lever Door Handle on Backplate

Finishes:  
SSS  
PSB  
PBK



TBH100 - Opera Lever Door Handle on Round Rose

Finishes:  
SSS  
PSB  
PBK



KM078 - Mitre Lever Door Handle on Backplate (Dual Sprung)

Finishes:  
SSS  
PSS  
PBK



KM060 - Mitre Lever Door Handle on Round Rose

Finishes:  
SSS  
PSS  
PSB  
PBK



HQ4R - Butt Hinge - Radius Corner

Finishes:  
SSS  
PSS  
PSB  
PPB  
MSB



HQ45 - Projection Hinge - Square Corner

Finishes:  
SSS  
PSS  
PSB  
PPB  
PBK



KM055 - Round Escutcheon - Euro

Finishes:  
SSS  
PSS  
PSB  
PPB  
PBK



Contemporary Suited Range in Polished Stainless Steel

## Security Products & Restrictor

AA76 - Door Viewer

Finish:  
SC



AA75 - Heavy Duty Door Security Chain

Finish:  
SC



FC6080 - Concealed Door Restrictors

Finish:  
SV



### Finish Code:

- SSS SATIN STAINLESS STEEL
- PSS POLISHED STAINLESS STEEL
- PSB PVD STAINLESS SATIN BRASS
- PPB PVD STAINLESS POLISHED BRASS
- PBK PVD STAINLESS SATIN BLACK

- MSB MATT SMOOTH BLACK
- SC SATIN CHROME
- SV SILVER PASSIVATED

Fittings from other manufacturers can be supplied, however they may not come with a guarantee from GK Joinery. For more information about the product Scan QR CODE.





# SLIDING SASH WINDOWS



Sliding sash windows offer a timeless elegance to a property, whether it's for a new build or an older property.

Don't let cold wind and rattling keep you up at night. Our windows offer peace of mind with modern draft seals and fittings improve performance and energy efficiency







The weights and pulleys sliding sash window ensures the traditional character and charm of a period building is maintained, whilst incorporating the latest advances in timber window technology.

We offer both spiral balance or cord and weight mechanism.

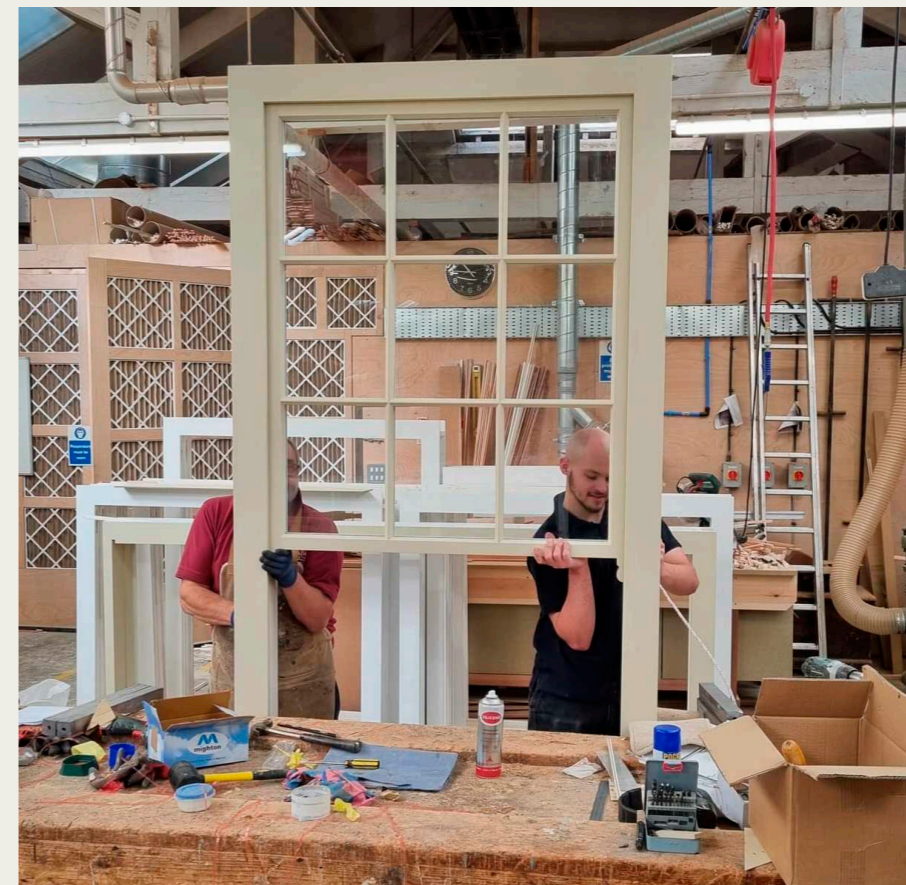
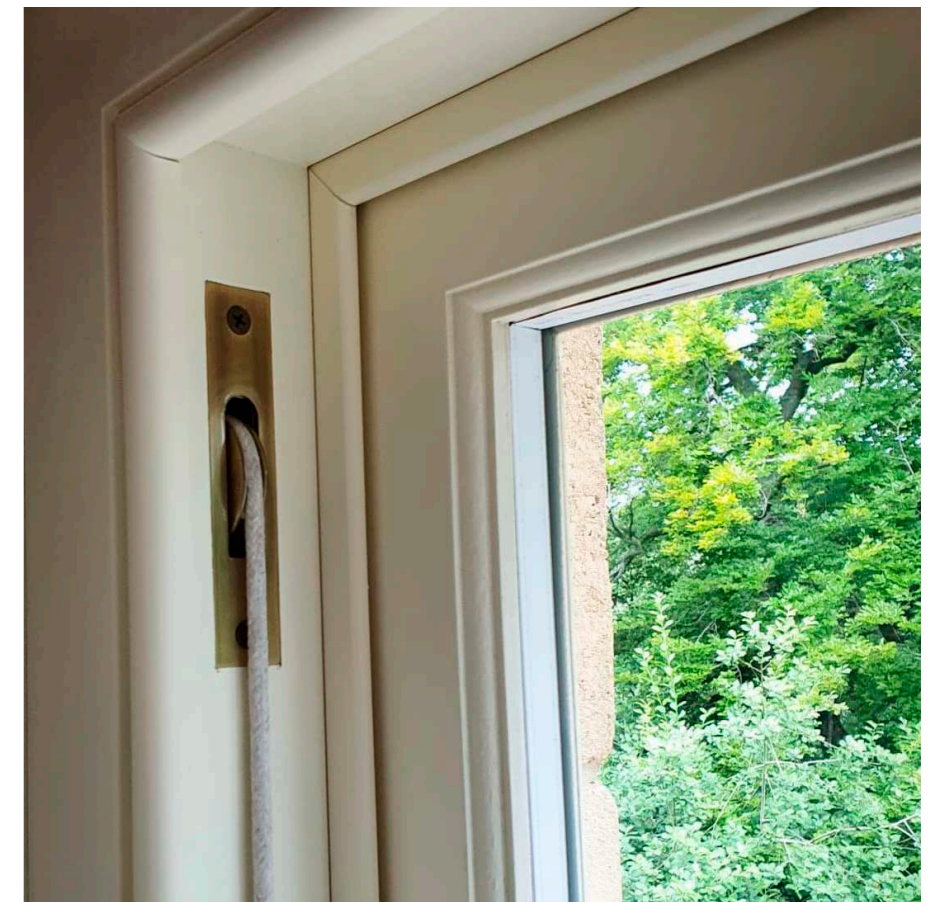

The spiral balance is a modern-day alternative to the classic box sash window, reproducing the original charm and character of an English sash window with a friction-based method of operation. A great option where a smaller frame is required.





# Sliding Sash Hardware

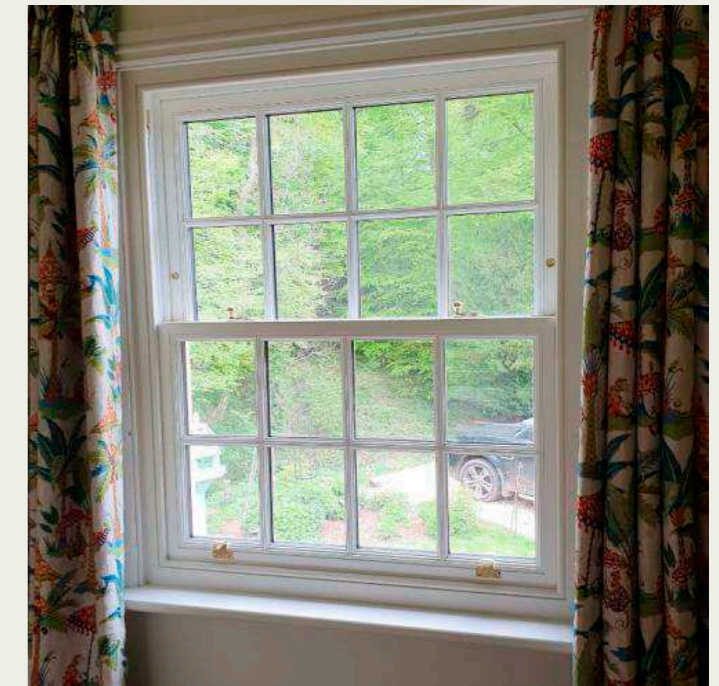
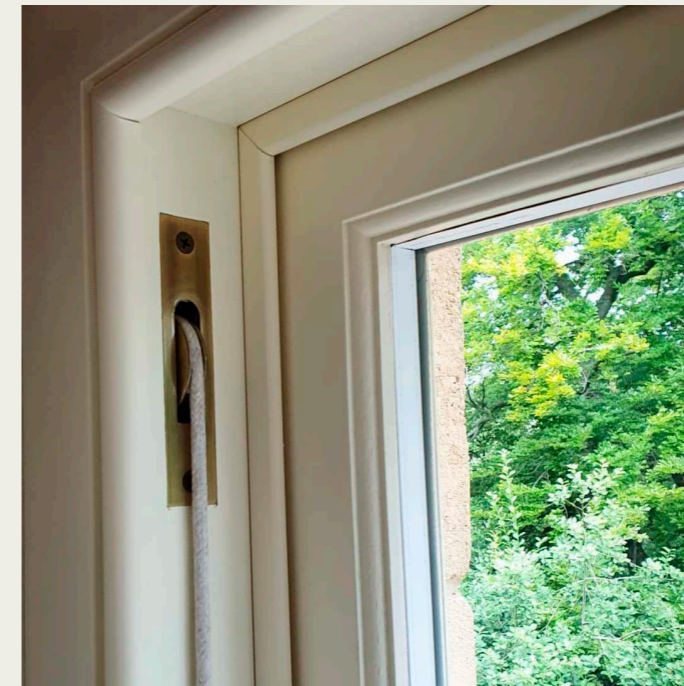

## MIGHTON PRODUCTS

Available in Polished Brass, Antique Brass, Polished Chrome, Satin Chrome, Satin Nickel, Black

PULLEY FITCH FASTENER QUADRANT FASTENER DEE HANDLE SASH LIFT RING PULL



Security sash stop  
Polished Brass,  
antique brass,  
satin nickel,  
satin chrome,  
polished chrome

External lining details square as standard. Ovolo or beaded options available

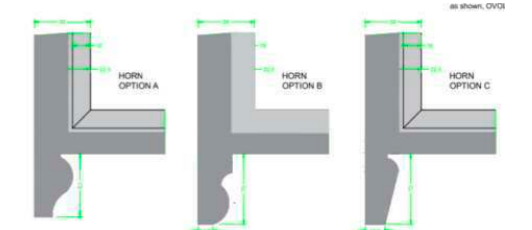



# Wallbridge Collection

## Bi-Fold Doors & Windows



Our timber Bifold Doors offer exceptional operation and insulation. Using the latest technology use Centor top rolling hardware to ensure smooth, effortless opening and closing of your doors.



### Let the light in

Modern 24mm double-glazed units ensure you keep warm on those cold winter nights. With a vast range of configurations, we have the knowledge and expertise to advise on the best solution for your home.



Aluminium cillas standard  
Full timber cilloption available

#### Common panel layouts

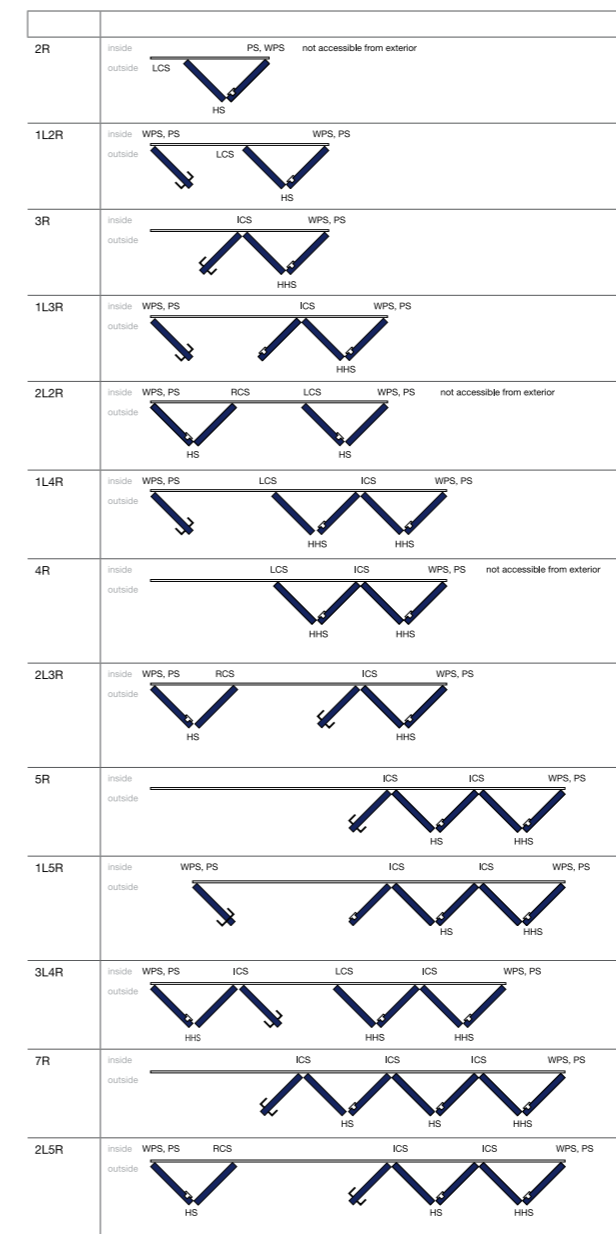

#### Common panel layouts

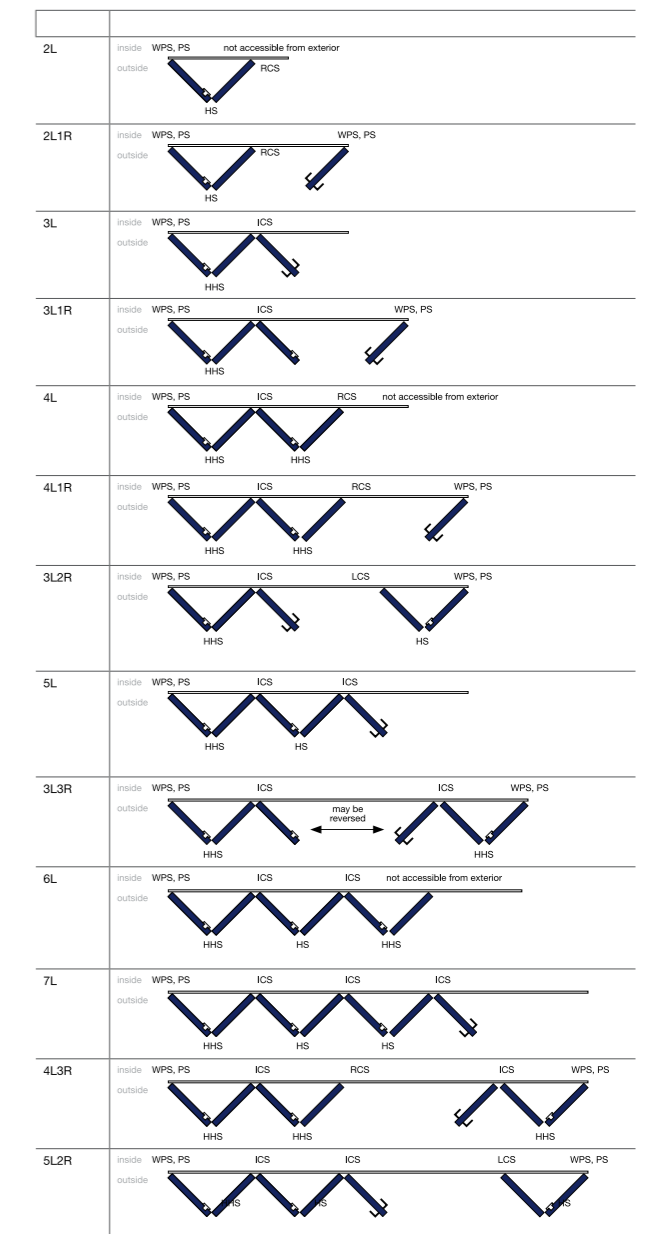



# Screen & Shade Systems

There's no denying bi-folds and other large doors transform your home. How else can you achieve such luxurious open plan living that lets you connect seamlessly with the outdoors?

## Shades

Luxury shade fabrics available in exterior, light-filtering and blackout with a choice of stylish patterns and a range of colours to suit every home.



### Light-filtering

This translucent blind material allows natural light inside while protecting from harsh sun and glare during the day and provides homeowners with a degree of privacy in the evening.



### Blackout

Our blackout shade is room-darkening, excluding light and providing complete privacy when drawn.

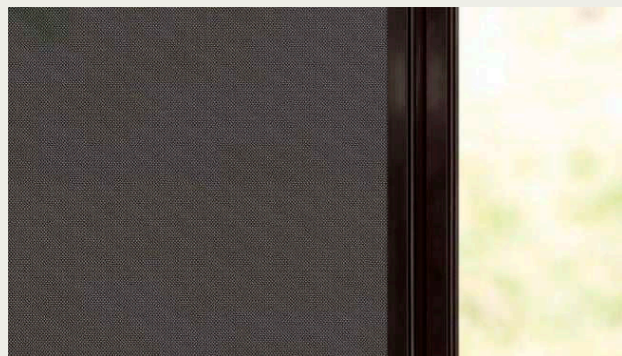

### Sun-filtering

Perfect for reducing glare, solar heat gain and fading. Can be fitted internally or externally but a popular choice for outside given its hard-wearing, easy-clean qualities.

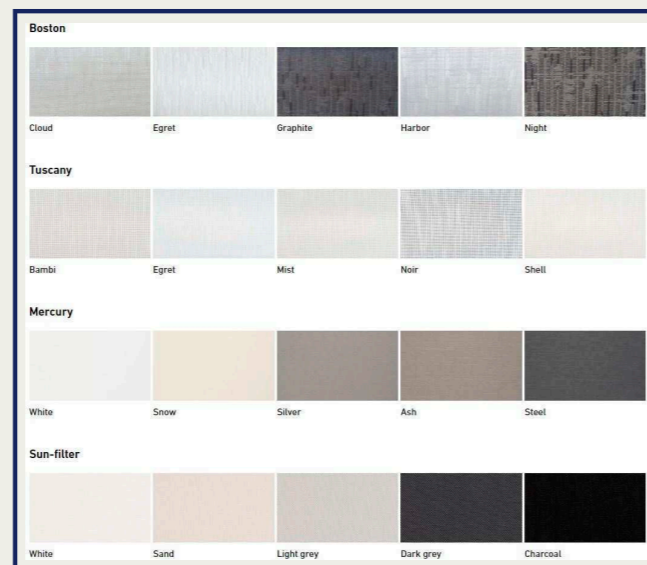

When planning a renovation or new build it's easy to be distracted organizing your beautiful bi-folds or sliding doors - but what will you do when you need a little privacy? How will you manage sun glare or control insects? Centor's award-winning S4 Screen & Shade System - with retractable insect screens and shades - takes care of that for you. Our unique products are built into the wall, meaning screens and shades are there when needed and hidden when not.

## Insect screens

Choose between two types of mesh and enjoy fresh air and an evening breeze without the inconvenience of insects. The mesh also acts as an anti-glare sunshade on bright, sunny days.

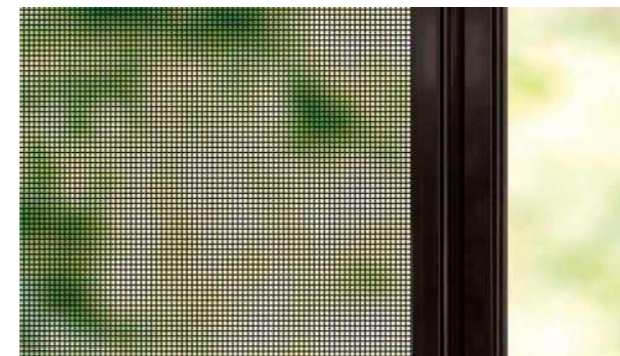

### Standard weave

Our standard weave screen keeps insects like moths, flies and mosquitoes outside, while standing the test of time with a durable polyester/PVC mesh construction.

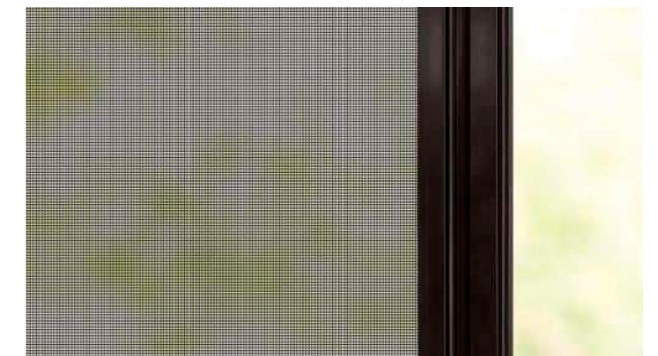

### Tight weave

Our tight weave mesh is made from the same durable material as our standard weave, but features a smaller aperture to protect homeowners from tiny insects like midges.





# Bespoke & Heritage Items



We have worked on a number of listed buildings, where matching the existing design to maintain the heritage of the building is a top priority.



# Looking for something different?

We have manufactured bespoke joinery for period and listed properties within the Cotswolds for over 40 years.



We can work with you to achieve your desired design.

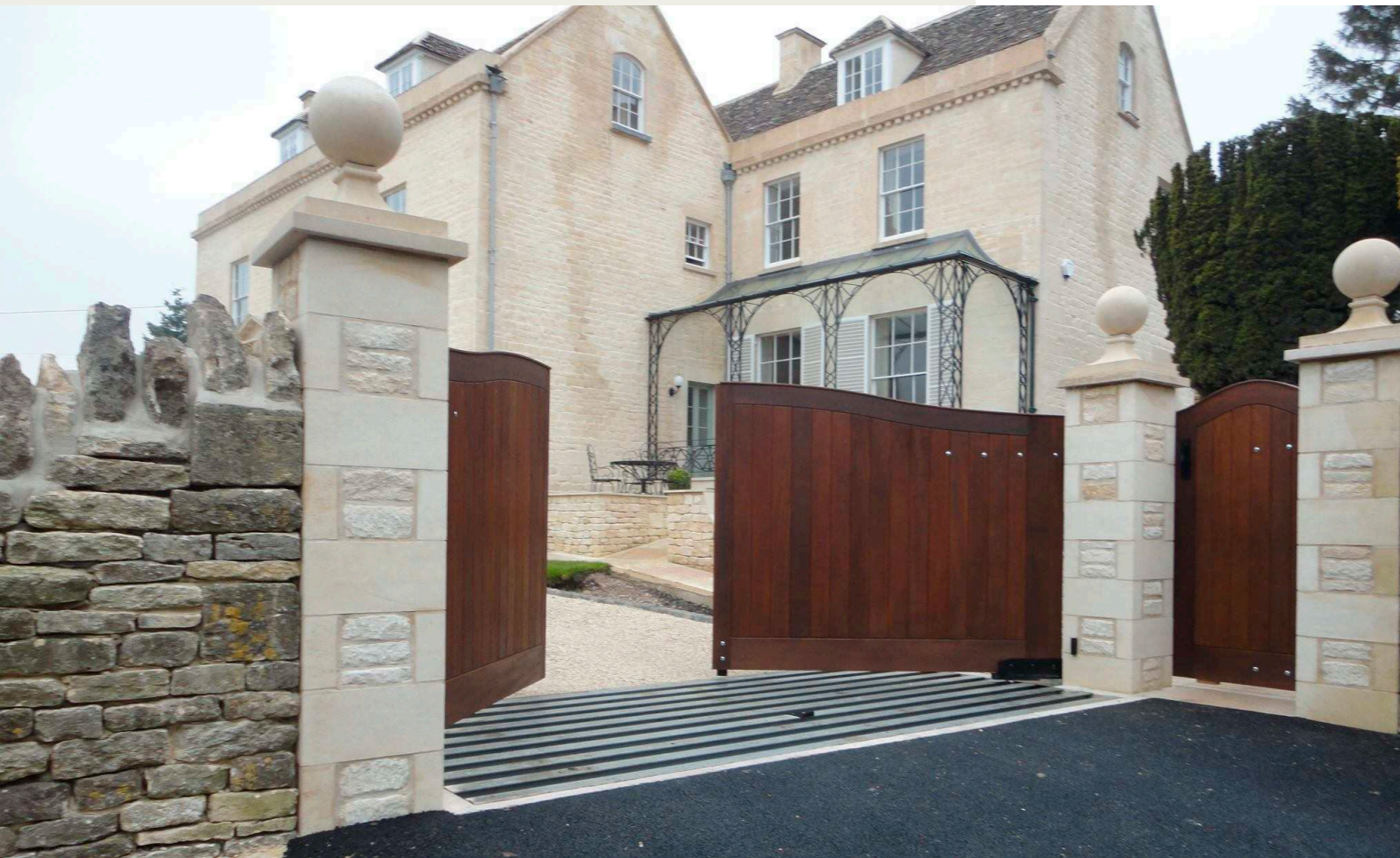
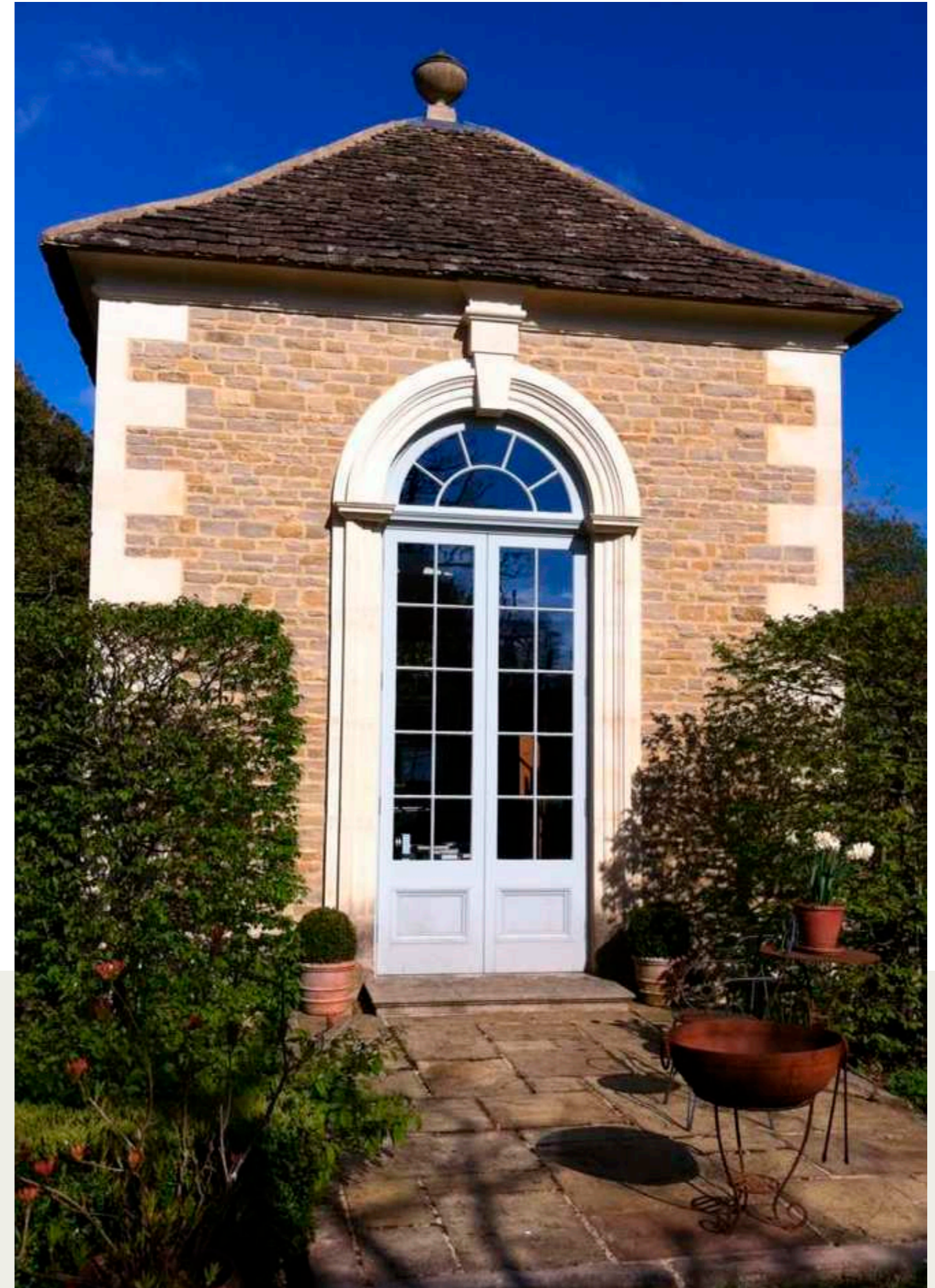



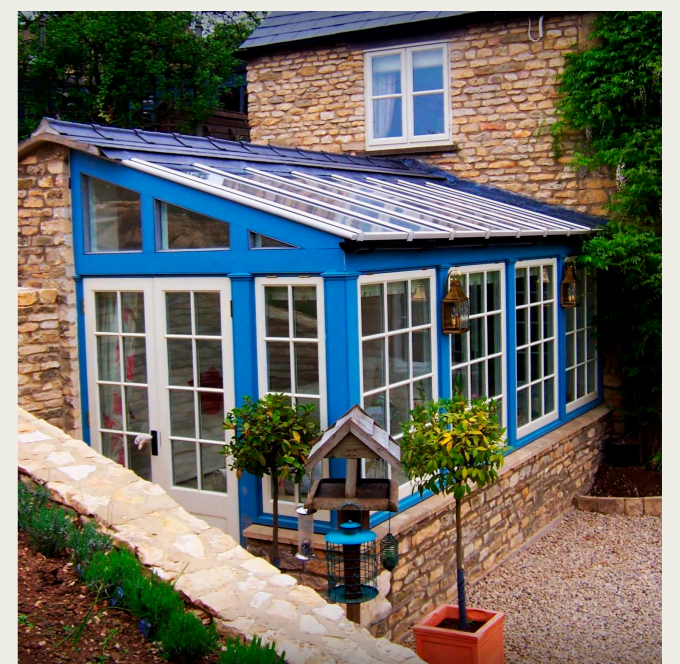



# Staircases

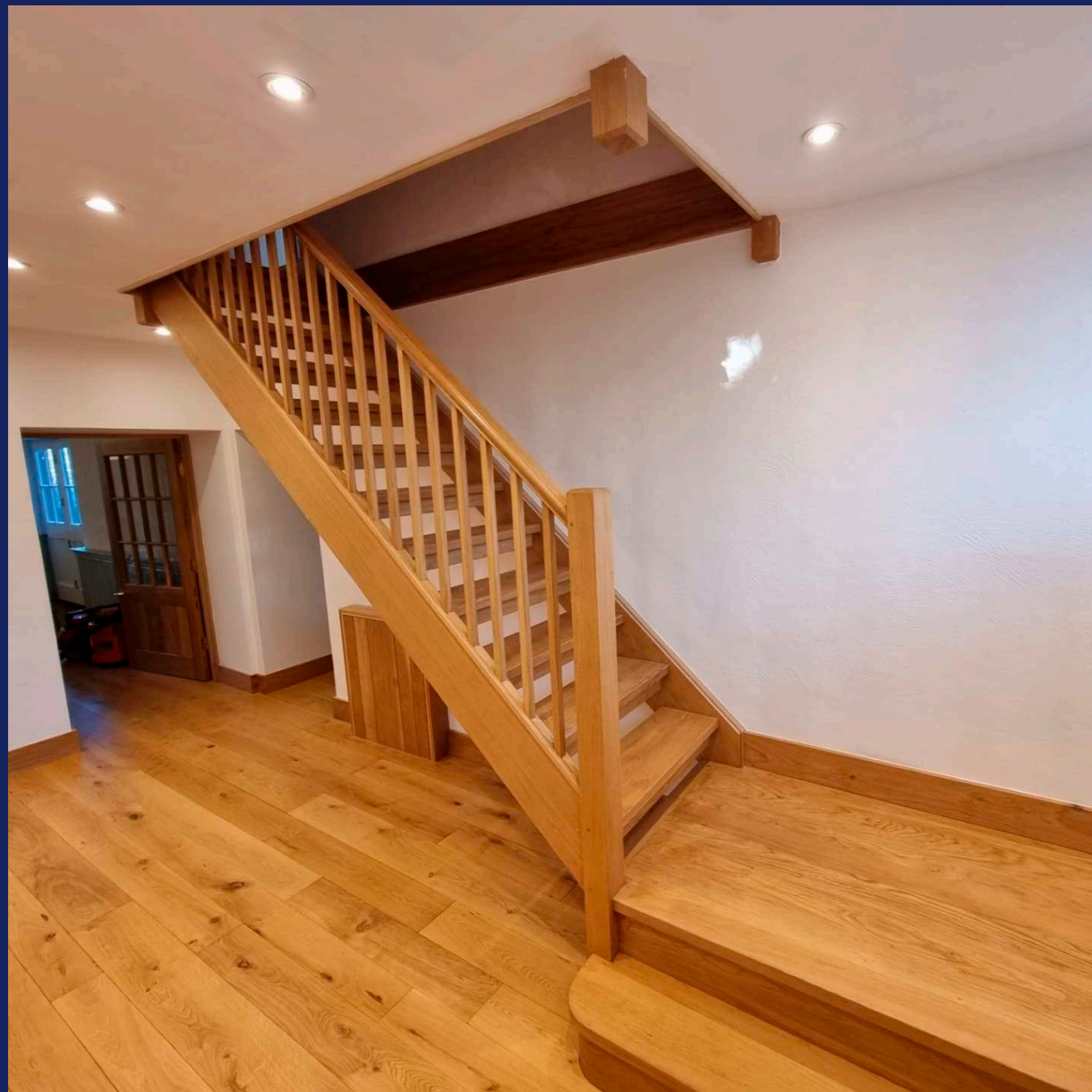

We can make your staircase in any specification or configuration. We can manufacture staircases using a combination of materials and finishes to achieve your desired look and feel.



At GK Joinery we pride ourselves on the quality of all our hand built products.

All of our staircases are expertly crafted and every component is fitted into place in our workshop to ensure the perfect hassle-free fit in your home.





# Staircases

## OPEN TREAD STAIRCASE –WITH CLOSED STRING

Open stairs have an open space where you would normally see a riser. Building Regulations stipulate that gaps should be no wider than 100mm so we use a riser downstand below the tread.

## CUT STRING STAIRCASE

Cut string staircases offer a grand luxurious feel. The strings are cut to accommodate the treads and risers, brackets are often fitted for aesthetics.

## CLOSED STRING STAIRCASE

A closed string staircase is the most common design style of staircase. The strings enclosed the treads and risers which are housed into them and wedged in place.

## BULL NOSE AND CURTAIL 'D' STEPS

These type of steps are entry steps at the bottom of a staircase. They offer a more open feel and increase entry room to the stairs.

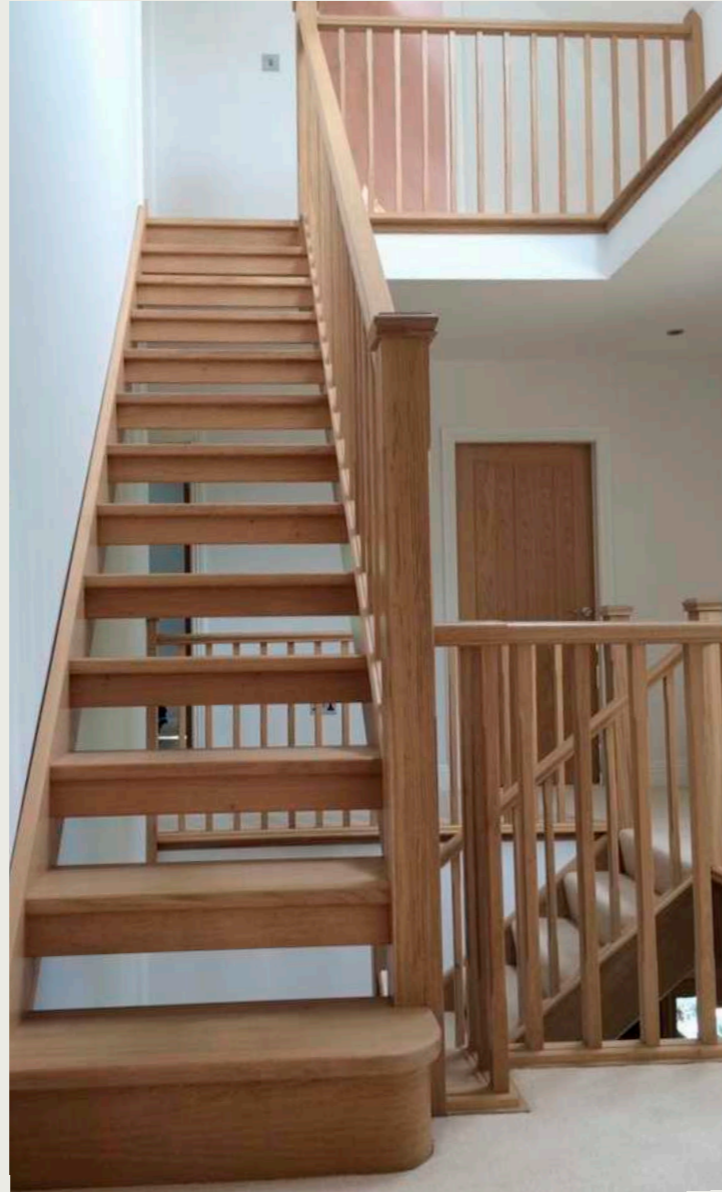

## Components of a Staircase

We hate jargon as much as the next person, but there are some industry standard terms that make it easier for us to understand each other.

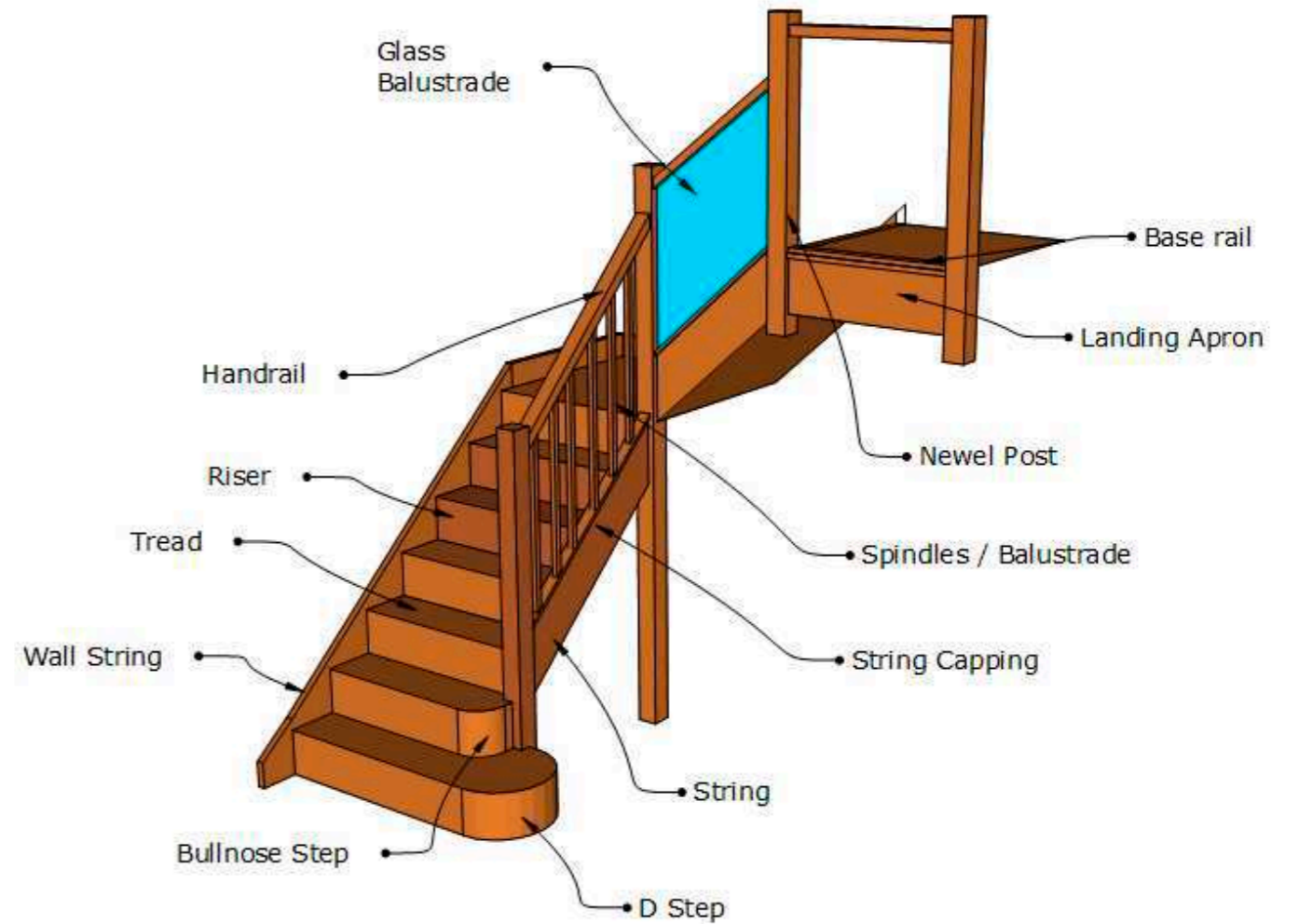
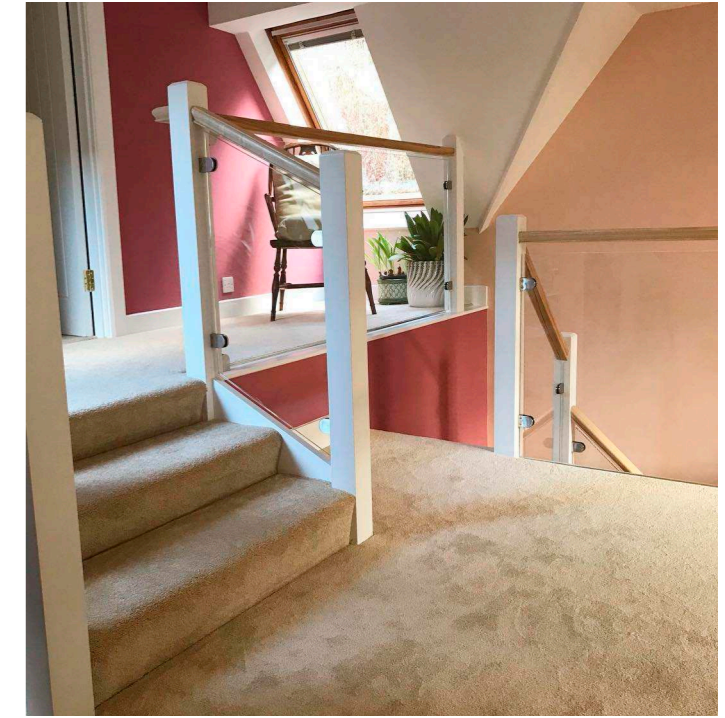

Straight Flight

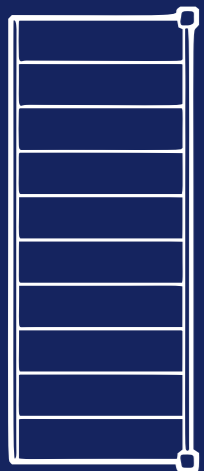

Quarter Turn

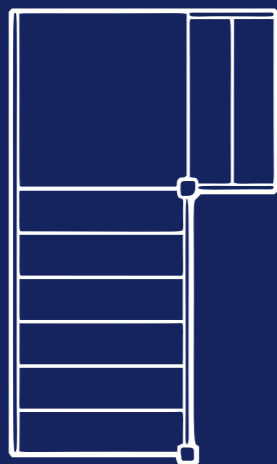

Half Turn

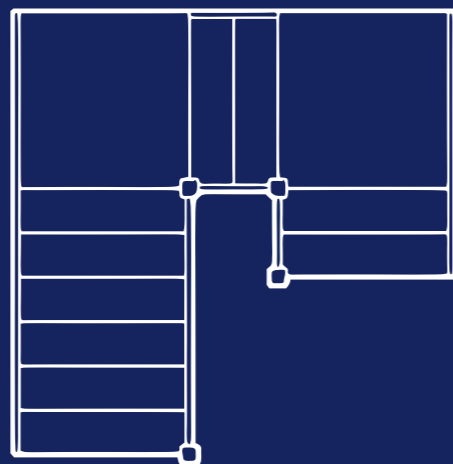

Winder Staircase





# TIMBERS

We use a variety of sustainably sourced timbers.  
Here are some of our favourites

## Red Grandis

Red Grandis is GK's preferred hardwood for casements, windows, and door frames.

\*Engineered for strength and stability

\*Sustainable Ethically sourced 100% FSC® certified

Red Grandis is a wood that varies in colour from pink to white, cream to light rose; however, its claim to fame likely belongs to the fact that it is certifiably green. It is the trademarked name for hardwood from a plantation-grown Eucalyptus tree (Eucalyptus grandis) that boasts FSC certification.



## Accoya

All our external doors are manufactured in accoya to reduce the risk of seasonal movement. It can also be used for our casement and sliding sash windows. Accoya can be painted or stained.

Accoya brings unprecedented reliability for timber; trusted not to visibly swell, shrink or distort, with minimal movement. Highly durable, it withstands the test of any climate.

Accoya is the truly sustainable choice that helps you meet global challenges like climate change. From source to production and through to end of life, sustainability shines through. Accredited by the FSC® and Cradle to Cradle Gold certified™



**Sapele** Sapele is a timber originating from tropical Africa. A tight interlocking grain with a dark red colour that resembles mahogany. Recommended use for cills and thresholds.



**Iroko** Iroko has a medium to coarse texture, with open pores and an interlocked grain. The wood is tough, dense, and very durable. It is often used as a substitute for teak for its resemblance in both colour (light brown to deep golden-brown) and grain. Commonly used for gates.



**European Oak** Aside from the obvious physical advantages, appearance is one of the major reasons oak is so desirable as a building material. It naturally possesses a pleasing golden colour that dries to a pleasant silvery tone when untreated. We use oak for doors, windows, staircases and other internal joinery. When used externally coatings will need regular maintenance intervals.



**Ash** In general ash is a light-coloured wood, with sapwood varying from white to yellow and heartwood light to dark brown, sometimes with lighter streaks. Ash wood is generally straight-grained with a coarse uniform texture. No two pieces are ever the same in appearance. Ash is not for exterior use.



**Tulipwood (poplar)** Colour ranges from white to pale olive green or brown. It is straight-grained, of even texture and grain and relatively strong. Its main uses are in furniture, doors, panelling, architectural interior joinery and mouldings, and kitchen cabinets. The timber is typically painted. Tulipwood is not for exterior use.



**Redwood (softwood)** Redwood is a pine often referred to as Scots Pine. The sapwood is creamy-white to yellow in colour. We traditionally use redwood for skirtings, mouldings and stair components.

**We advise against using redwood externally.**

## KEY FEATURES & BENEFITS



DIMENSIONALLY STABLE



OUTSTANDING DURABILITY



PERFECT FOR COATING





# FINISHES

## Finishes

Our joinery is finished by our own in-house team using high-quality microporous products available. Our painted and translucent stain finishes for Accoya are spray applied and dried under controlled conditions.

For door frames with a painted finish, we stain our thresholds with a quality oil-based stain.



**On Accoya** BASE: Walnut TOP: Antiquw Oak  
**On Accoya** BASE: Dark Brown TOP: Walnut  
**On Accoya** BASE: Teak TOP: Walnut  
**On Accoya** BASE: Teak TOP: Nut  
**On Accoya** BASE: Teak TOP: Iroko  
**On Accoya** BASE: Cotswold Oak TOP: Cotswold Oak

## Dual Finish

We offer a dual colour finish where the exterior colour is different to the internal colour



# GLASS

Our doors and windows come with energy efficient A-rated 24mm double glazing as standard. Using the latest technologies our glass has a U value of just 1.2.

## Glass Options

GK also offer speciality glass such as leaded, frosted (satin), sand blasted detail i.e. for house numbers, acoustic, self-cleaning, anti-sun and more are available.

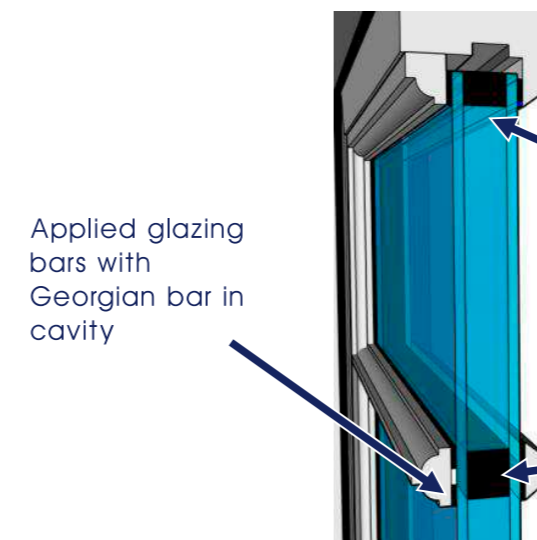
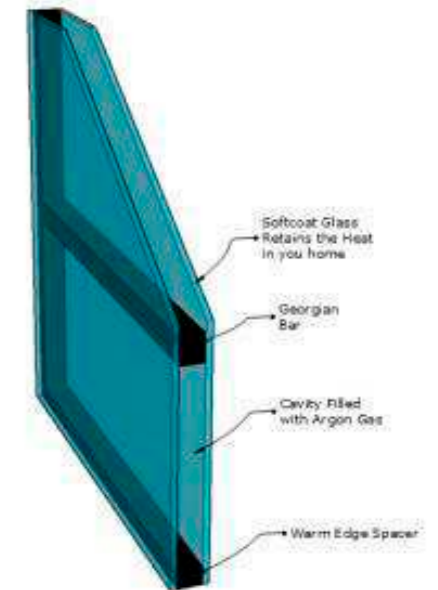

Applied glazing bars with Georgian bar in cavity

Warm edge spacer bars which make up the perimeter of the double glazing come in black as standard. White or grey are available by request

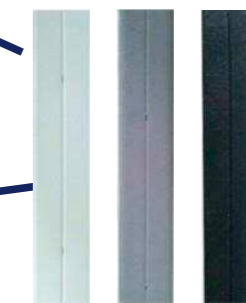

## Single Glazing & Slim Heritage Double Glazing

Details are paramount when retaining a buildings established appearance. Single and slim glazing can be used on listed buildings where standard double glazing options are not deemed suitable for either architectural, planning or conservation reasons.

Slim heritage glazing where permitted can be used to improve your homes thermal performance. With a small sightline and only a 4mm air gap it helps to retain the warmth in you home without compromising the visual appearance of your doors and windows. With a U Value of 1.9 using 4mm softcoat / 4mm cavity filled with Krypton gas / 4mm float, it improves single glazing 5.9 U Value

